

NOT / NOTES:

- TİP / TYPE: I30
- ELEKTRİKSEL DEĞERLER
ELECTRICAL FEATURE: 1)16A/250V -2)10A/400V
- OPERASYON DEVİR SAYISI /
NUMBER OF OPERATING CYCLES: 1)10E3 - 2)30E3
- ÇALIŞMA SICAKLIĞI /
WORKING TEMPERATURE: T150°C
- GÖVDE PLASTİK MALZEMESİ
BODY OF PLASTIC MATERIAL: PA 6,6 GF 25 V0
- GÖBEK MALZEMESİ
SHAFT MATERIAL: PA 6,6 GF 25 V0
- KAPAK MALZEMESİ
COVER MATERIAL: PA 6,6 GF 30 DIOXINE FREE, UL94 FR V0 HEAT STABILIZER AND FLAME RETARDANT.
- TERMİNALLER
TERMINALS: 6,3x0,8 EN 61210
- KONTAKLAR
CONTACTS: Ag Ni 90% - 10%
- ANAHTARLARIN DÖNÜŞ POZİSYONLARI SAAT YÖNÜNDEDİR.
THE COMMUTATION POSITIONS TO BE GOT BY MEANS OF CLOCKWISE TURNING.
- KAM POZİSYONUNDA BOŞLUK OLMAMALIDIR.
THE SHAFT COMBINATION TO BE WITHOUT ANY BACKLASH
- GÖBEK DÖNÜŞ KUVVETİ (ODA SICAKLIĞINDA)
SHAFT ROTATION FORCE (AT ROOM TEMPERATURE) : 25 ±10 Ncm
- TERMİNAL MALZEMESİ
TERMINAL MATERIAL: DÜŞÜK KARBON ÇELİĞİ / LOW CARBON STEEL 1010 (5µCu,2µNi)
- ONAYLI İŞARETLER
APPROVAL MAKINGS

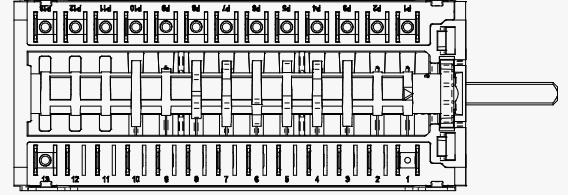

KAPAKLI / WITH COVER

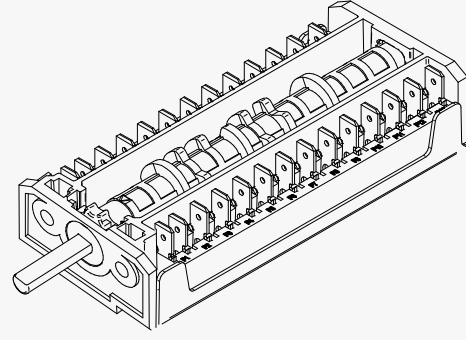
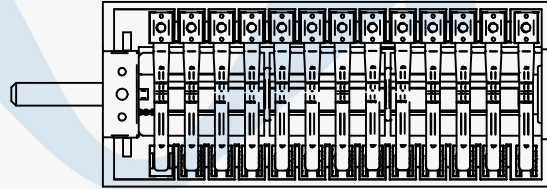

KAPAKLI / WITH COVER

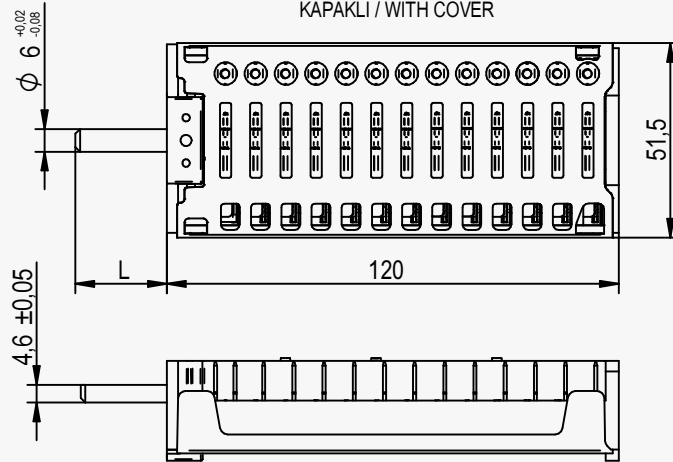

AN-EL ANAHTAR VE ELEKTRİKLİ EV ALETLERİ SANAYİ A.Ş.

TELEFON : +90 216 307 74 01

<http://an-el.com.tr> info@an-el.com.tr

9001

DEVRE SEMASI / CIRCUIT DIAGRAM

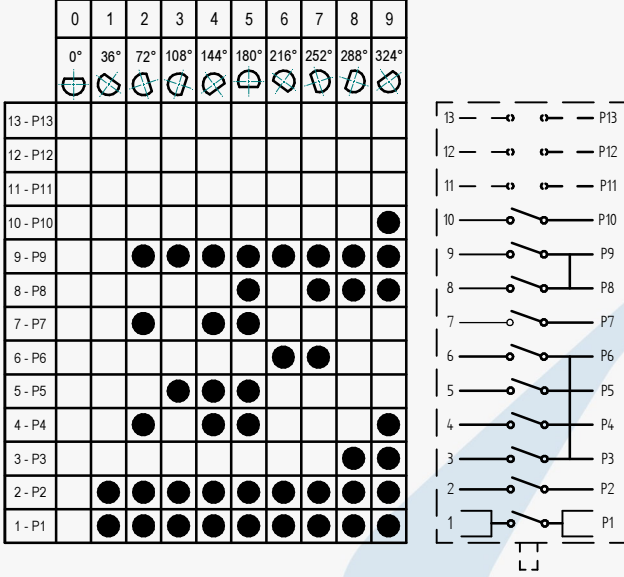

9003

DEVRE SEMASI / CIRCUIT DIAGRAM

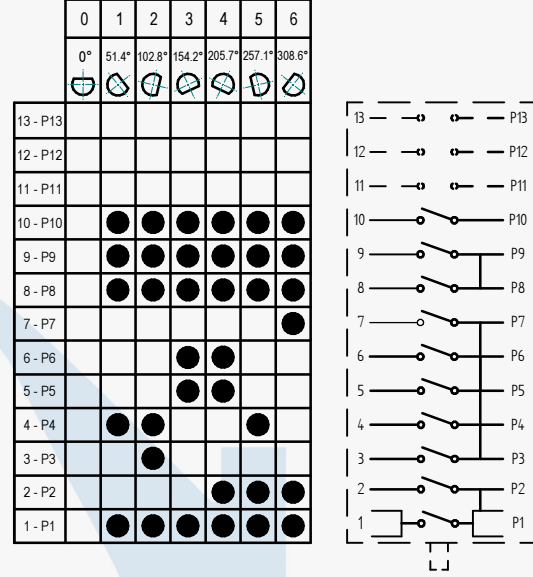

9004

DEVRE SEMASI / CIRCUIT DIAGRAM

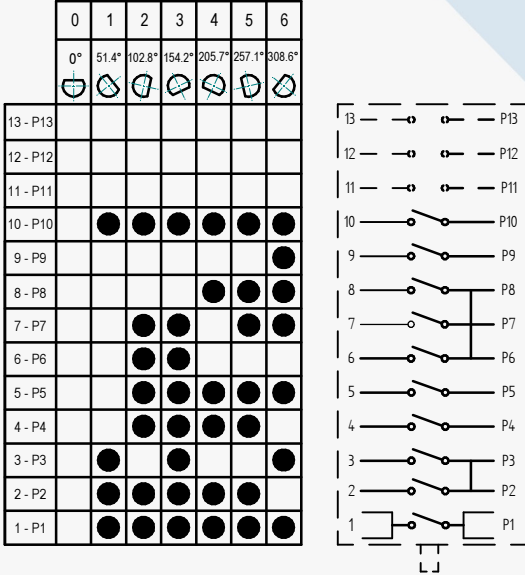

9005

DEVRE SEMASI / CIRCUIT DIAGRAM

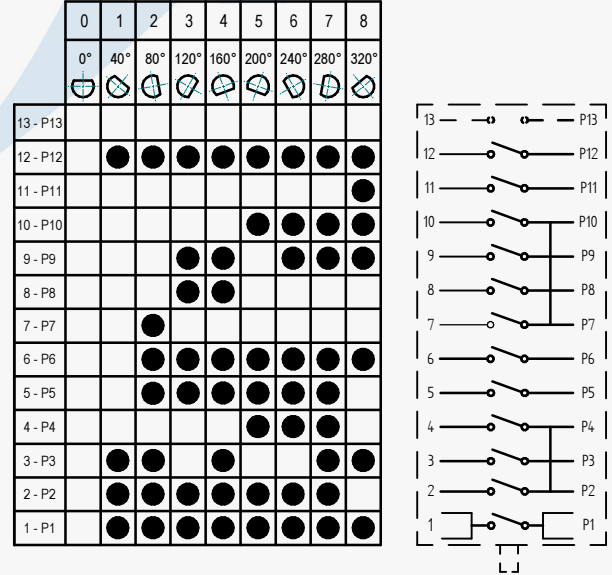

AN-EL ANAHTAR VE ELEKTRİKLİ EV ALETLERİ SANAYİ A.Ş.

TELEFON : +90 216 307 74 01

<http://an-el.com.tr> info@an-el.com.tr

9006

DEVRE SEMASI / CIRCUIT DIAGRAM

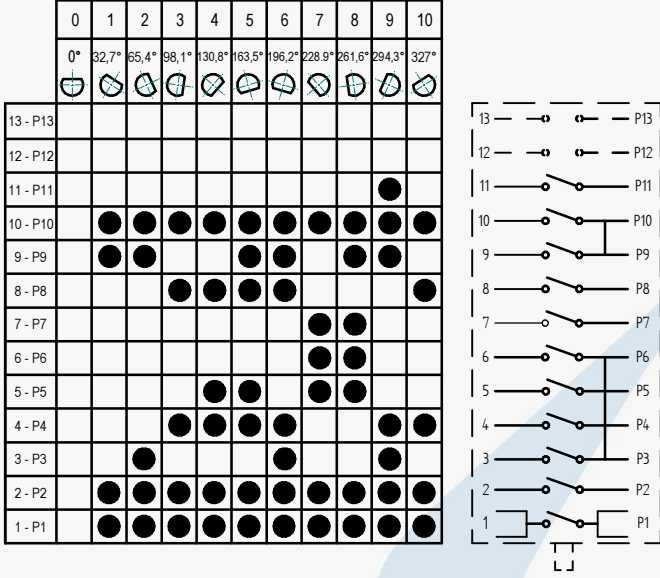

9007

DEVRE SEMASI / CIRCUIT DIAGRAM

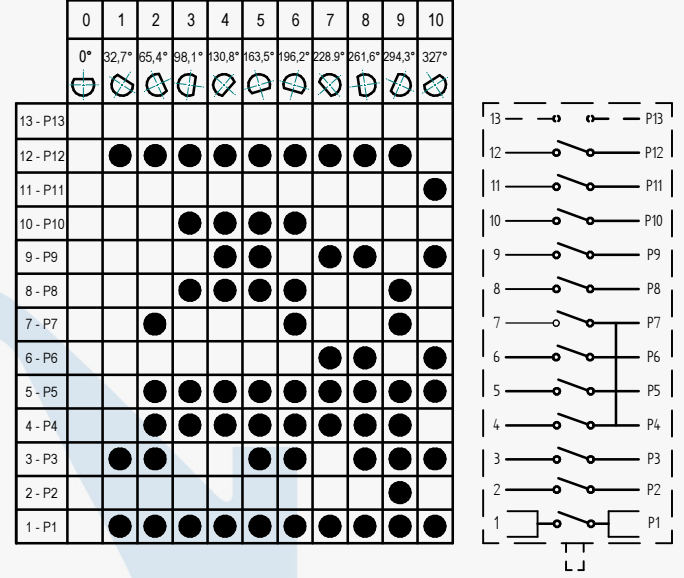

AN-EL ANAHTAR VE ELEKTRİKLİ EV ALETLERİ SANAYİ A.Ş.

TELEFON : +90 216 307 74 01

<http://an-el.com.tr> info@an-el.com.tr