

PANEL CUT
MONTAJ ÖLÇÜSÜ

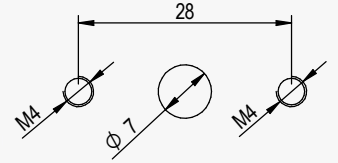

4 BIT

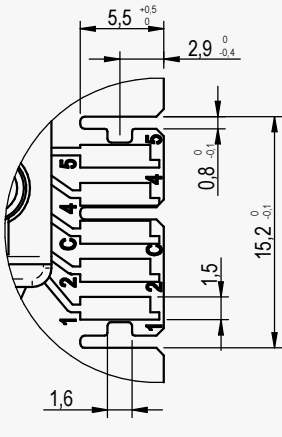

DETAY / DETAIL B

KARE DALGA + PULSE
SQUARE WAVE + PULSE

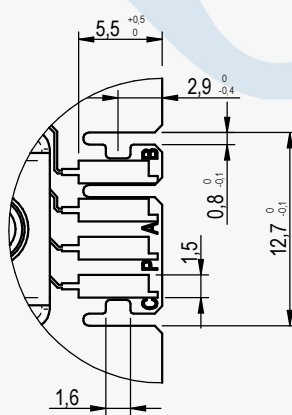

DETAY / DETAIL B

DİRENÇ BÖLÜCÜ
RESİSTOR DIVIDER

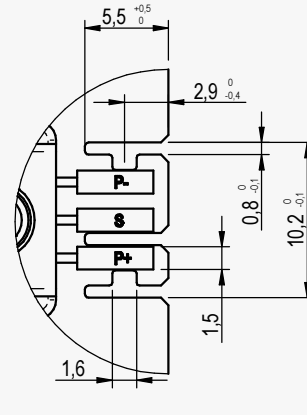

DETAY / DETAIL B

4 Bit

Kare Dalga / Square Wave

Kare Dalga + Pulse / Square Wave + Pulse

Analog Çıkışlı Artımlı Direnç Bölücü

Incremental Resistor Divider With Analog Output

AN-EL ANAHTAR VE ELEKTRİKLİ EV ALETLERİ SANAYİ A.Ş.

TELEFON : +90 216 307 74 01

<http://an-el.com.tr> info@an-el.com.tr

ENCODER EN 01

4 BIT

0+6 Poz. / Pos.

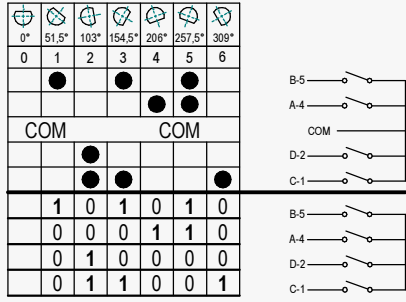

0+8 Poz. / Pos.

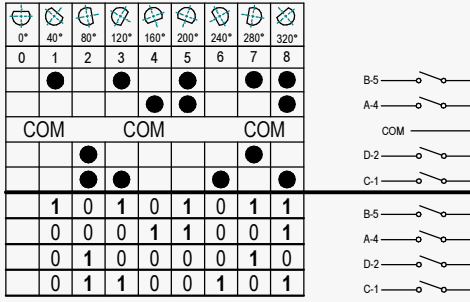

0+10 Poz. / Pos.

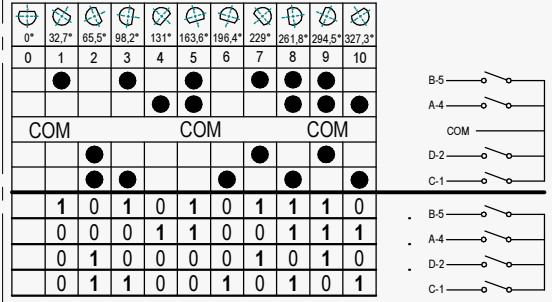

0+7 Poz. / Pos.

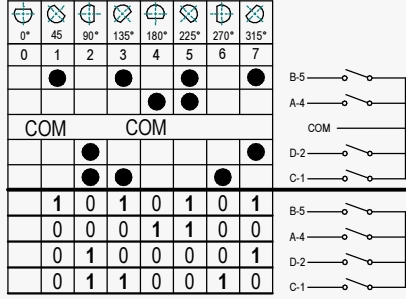

0+9 Poz. / Pos.

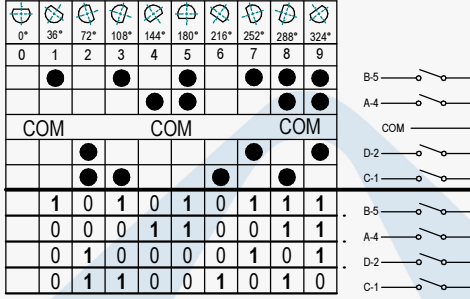

0+11 Poz. / Pos.

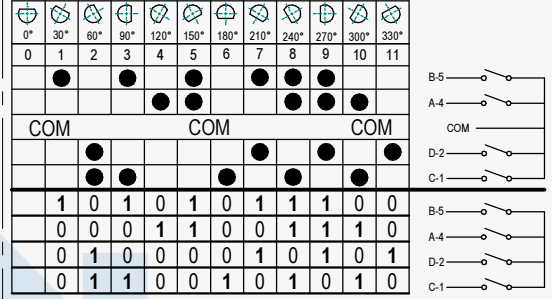

KARE DALGA / SQUARE WAVE

0+19 Poz. / Pos.

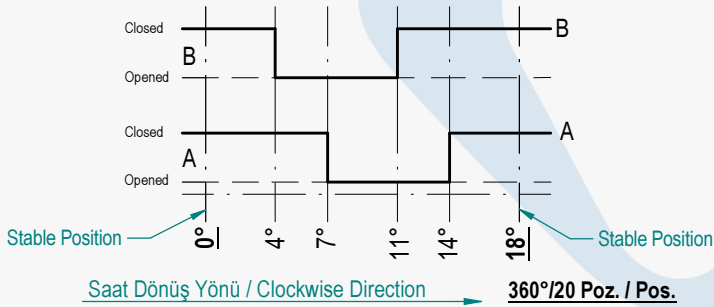

KARE DALGA DİRENÇ BÖLÜCÜLÜ SQUARE WAVE RESISTOR DIVIDER

0+20 Poz. / Pos.

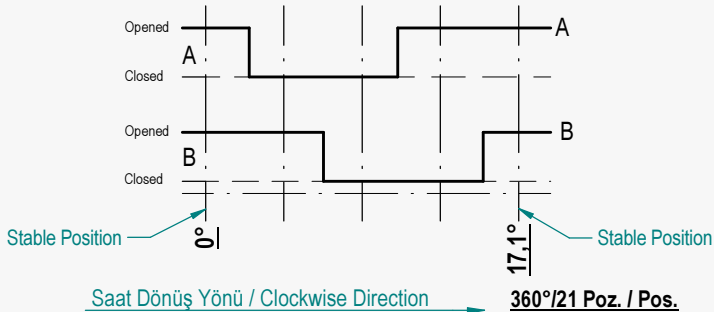

ENCODER DİYAGRAMLARI DIAGRAMS ENCODER EN 01